



GW300

# ***Solar LED*** **Trellis Tower**



*Thank you for purchasing this Solar LED Trellis Tower from Gardenwize. The instructions written below provides you with guidance on how to get best use of the product. We highly advise that you read these instructions before using the product.*

## Product Elements

1. Trellis tower (unassembled) - see table 1 for all components.
2. 100 LED solar string lights
3. Cable ties
4. Solar panel
5. Ground spike







Accessory	No.	Q'ty
	A	4
	B	12
	C	8
	D	4
	E	12
	F	12
	G	1

Table 1

## Assembly

1. Carefully remove all the components from the packaging. For the string lights, be careful when unravelling to avoid overstressing the cable or damaging the lights.
2. Assemble the trellis tower (see Figure 1).
3. Then, decorate the trellis tower with the solar string lights, using the supplied cable ties to secure onto the trellis tower's frame.
4. Attach the ground spike to solar panel.
5. Position the trellis in a suitable location and ensure the solar panel will get direct sunlight. Then place the ground spike into either grass or garden bed.

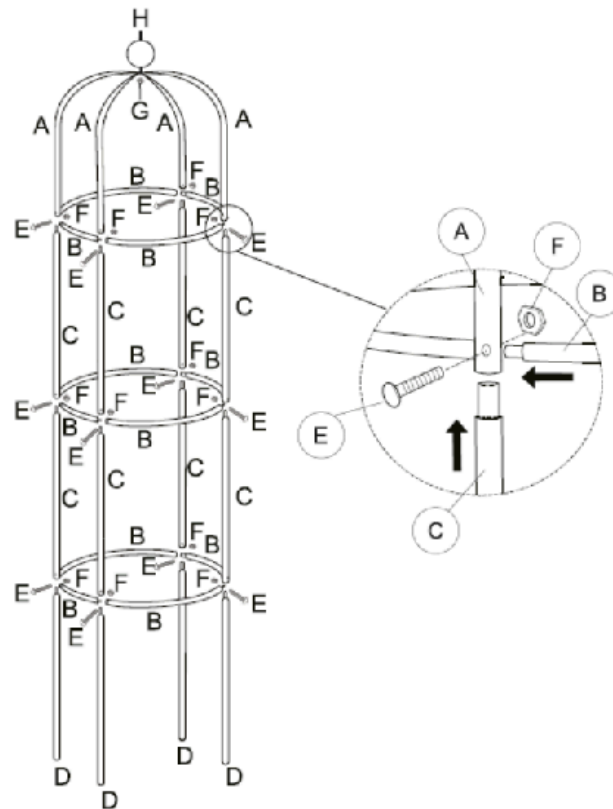

Figure 1

## On First Use

This trellis tower comes with a solar panel with a built-in rechargeable battery. Before using this product, we advise that you fully charge the battery by placing the solar panel under direct sunlight for a full 24 hour period.

## Dual Light Mode

The string lights come with dual light modes. The first mode gives a solid white light. The second mode provides flashing lights.

To activate either of these functions, please locate the slider switch behind the solar panel and set it to either 'S' for solid white light or 'F' for flashing.

The solar lights will automatically turn on at dusk and shut off at dawn.

To turn off, set to 'OFF'.

## Maintenance & Troubleshooting

Make sure the switch is set to the "ON" position.

Keep the solar panel clean.

If a solar product does not light up after it has been used for around 8 – 12 months, replace the rechargeable battery as it may be weak or worn out. (Battery 1 pc "AA" 1.2v 800Mah, Ni-MH, Rechargeable). Never use another battery with a different spec.

## Battery Replacement

1. Unscrew the battery compartment cover by using a Phillips head screwdriver (not included).
2. Open the compartment carefully and ensure that the battery terminals are not damaged.
3. Remove the old depleted battery and replace with 1 x new AA rechargeable battery.
4. Secure the battery compartment in place using the screws.

**Attention: Batteries must be recycled or disposed of in accordance with your local authority guidelines. Do not dispose of these near an exposed heat source or open flame or into your normal household waste. Remove the battery from the product if it is to be stored for a long period of time. Removal and/or replacement of the battery should only be carried out by an adult or under adult supervision.**

## Health & Safety

- Do not use the lights if the insulation or bulb have been damaged.
- Never allow the product to come into contact with excessive heat or naked flame.
- This product is not a toy. Keep away from pets and children, ensuring that children are supervised at all times.
- When disposing of this product, please do so in line with your local authority guidelines.

# Technical Specification

Name	Gardenwize Solar LED Trellis Tower - 100 LEDs
Supplier Code	GW300
LED	100 LED solar string light
Solar Panel	2V 100mA
Battery	1.2V 800mAh NI-MH
Size	195cm (8ft) x 40cm



---

**Streetwize:** Ashburton Road West, Trafford Park, Manchester M17 1RY

---

**For Product Support:**

**E:** [support@streetwizeaccessories.com](mailto:support@streetwizeaccessories.com)

**T:** +44 (0)161 447 8597

**For Trade Enquiries:**

**E:** [sales@streetwizeaccessories.com](mailto:sales@streetwizeaccessories.com)

**T:** +44 (0)161 447 8580

---

**[www.streetwizeaccessories.com](http://www.streetwizeaccessories.com)**

---