

Dahlia Hanging Chair

Information for use

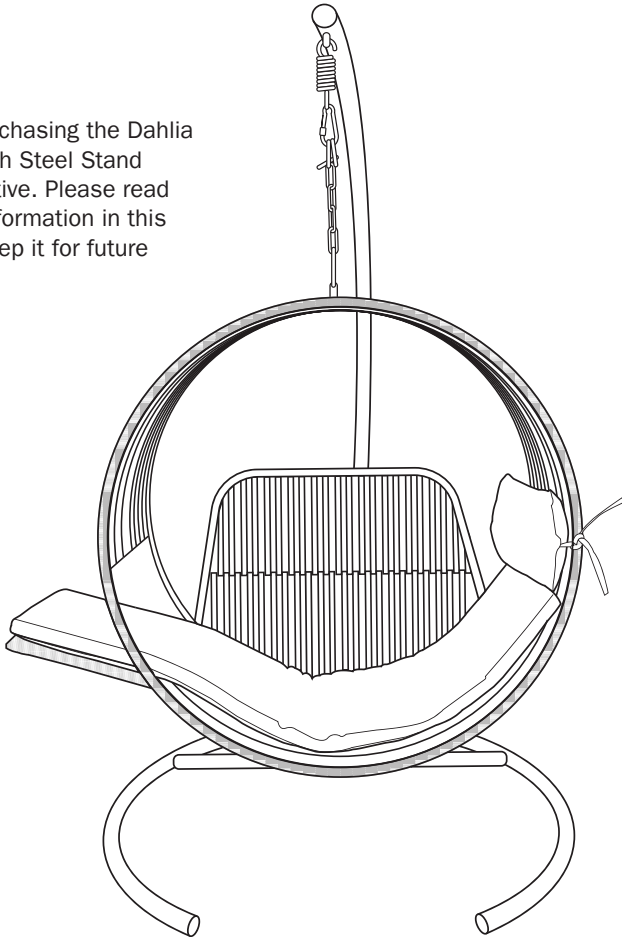















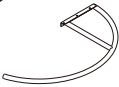











Thank you for purchasing the Dahlia Hanging Chair with Steel Stand from DMD Collective. Please read through all the information in this document and keep it for future reference.



Safety Guidelines

- Warning: This product has a maximum weight capacity of 120 kg. Only one person can use the chair at a time. Exceeding the weight limit or sharing the chair may result in injury or damage.
- Keep the chair away from heat sources, such as radiators or fireplaces, to prevent damage to the materials.
- Use caution when entering and exiting the chair. Avoid swinging, shaking, leaning, climbing, or standing on this chair to prevent injury or damage.
- Avoid placing heavy objects or storing belongings on the chair. Excess weight may damage the chair.
- Carefully unpack all components from the box. Ensure no parts are missing or damaged before assembly.
- Assemble the product on a firm, level surface. Ensure the frame maintains contact with the surface.
- Keep children away from the assembly process and supervise their use of the chair.
- Before use, make sure to securely assemble the chair. Regularly inspect the chair for any signs of wear and tear and tighten any loose bolts or nuts.

Parts Included

1 x1 	2 x1 	3 x1 	4 x1 	5 x1 
6 x1 	7 x1 	8 x1 	9 x1 	10 x1 
11 x1 	12 x1 	13 x8 	14 x9 	15 x17 
16 x9 	17 x8 	18 x1 	19 x3 	20 x6 
21 x9 	22 x18 	23 x9 	24 x9 	25 x1  13mm
26 x1  6mm	27 x1  10mm	28 x1  4mm		

Installation - Frame

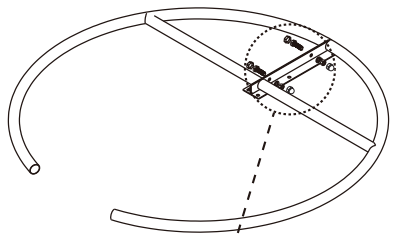
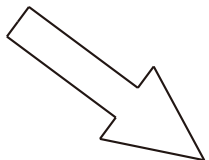
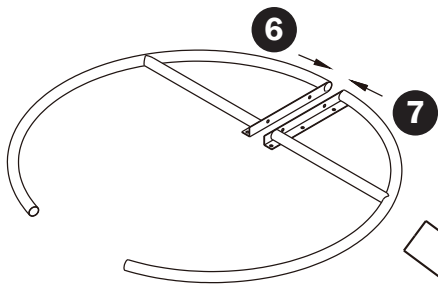
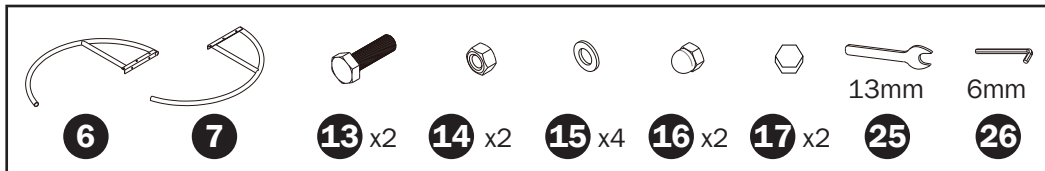

1. Secure the two parts of the base together (items 6 & 7), using the 13mm spanner & 6mm allen key as the diagram.

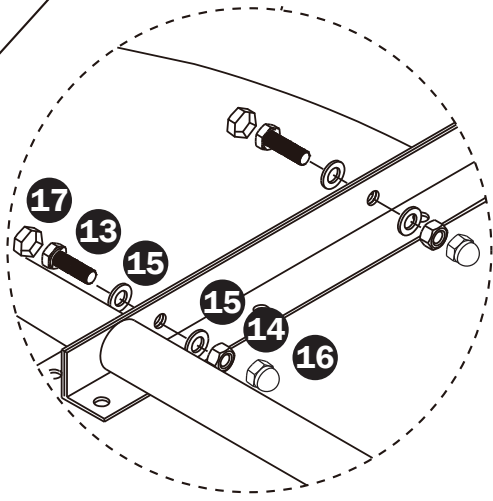
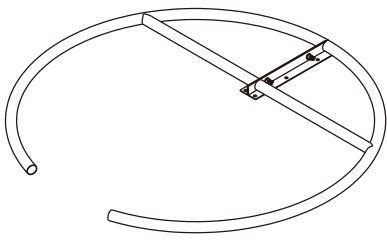
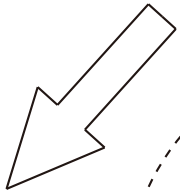

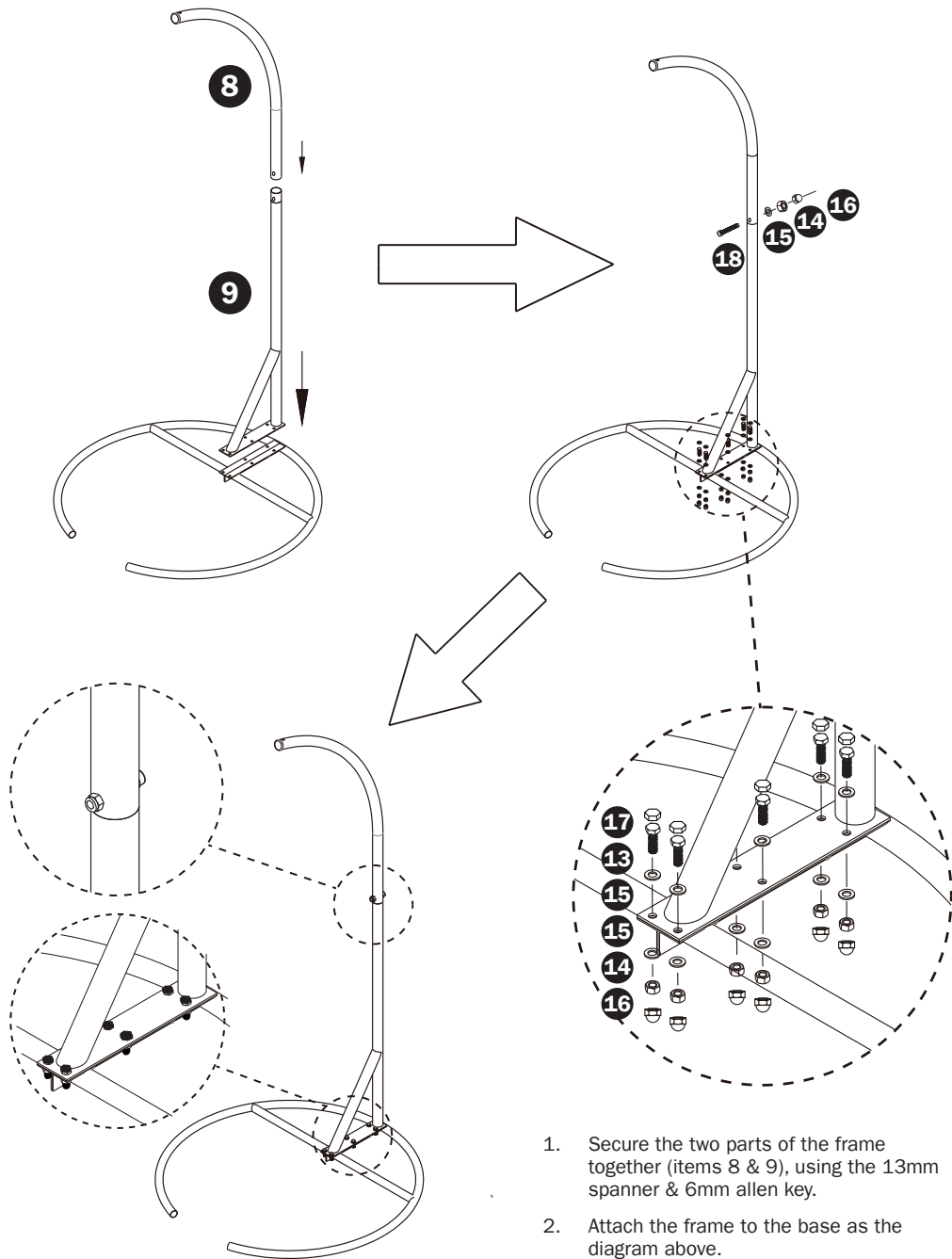
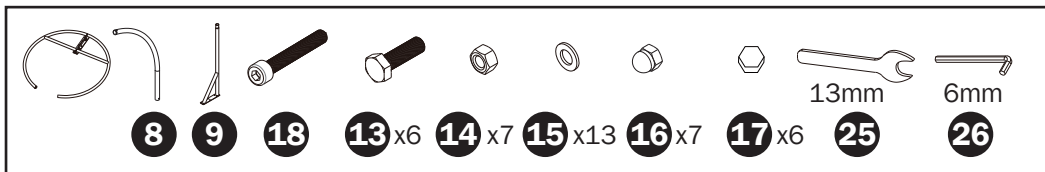

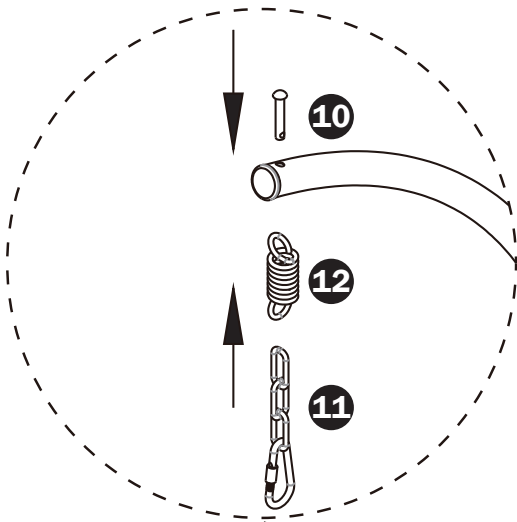

1. Once the frame & base are assembled, attach the hanging chain to the hole in the top of the frame using items 10, 11 & 12.

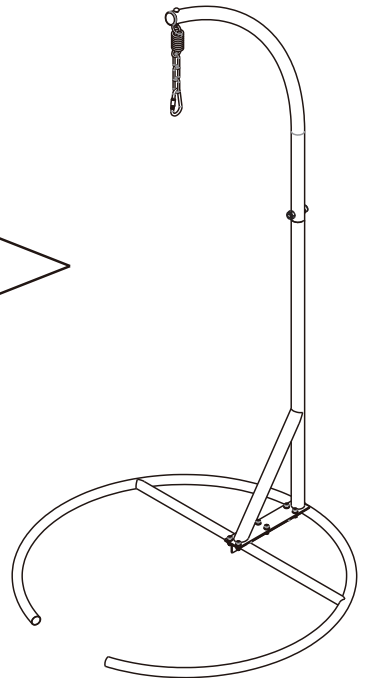
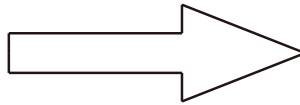
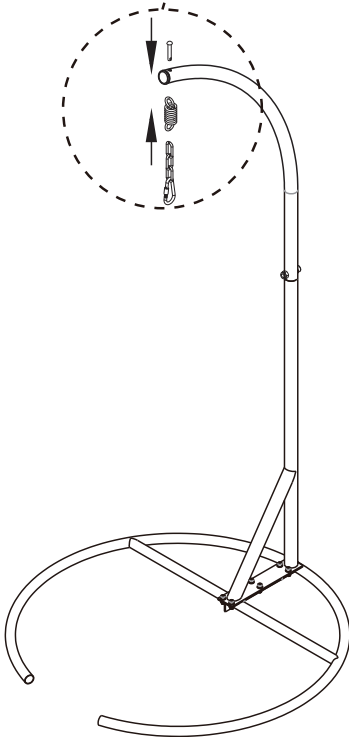

Installation - Basket

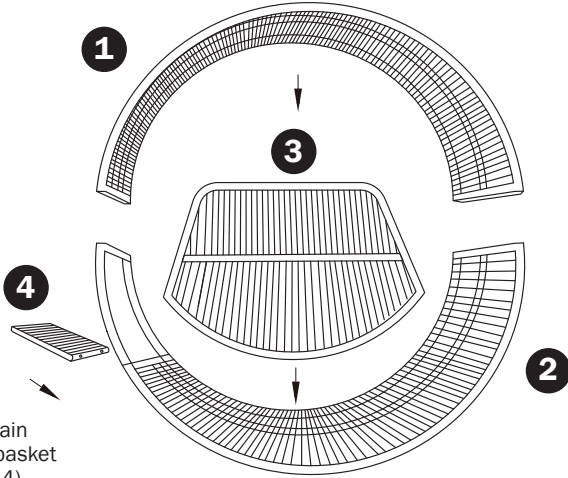
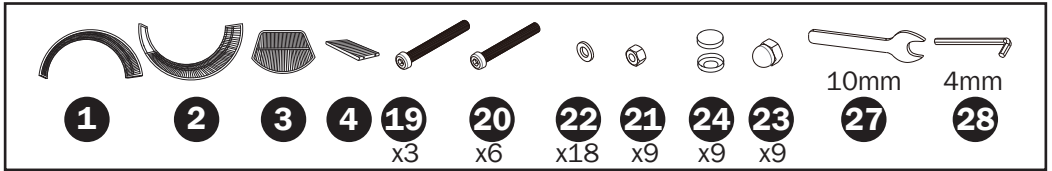

1. Assemble the main sections of the basket (items 1, 2, 3 & 4) using the 10mm spanner & 4mm allen key as the diagram below.

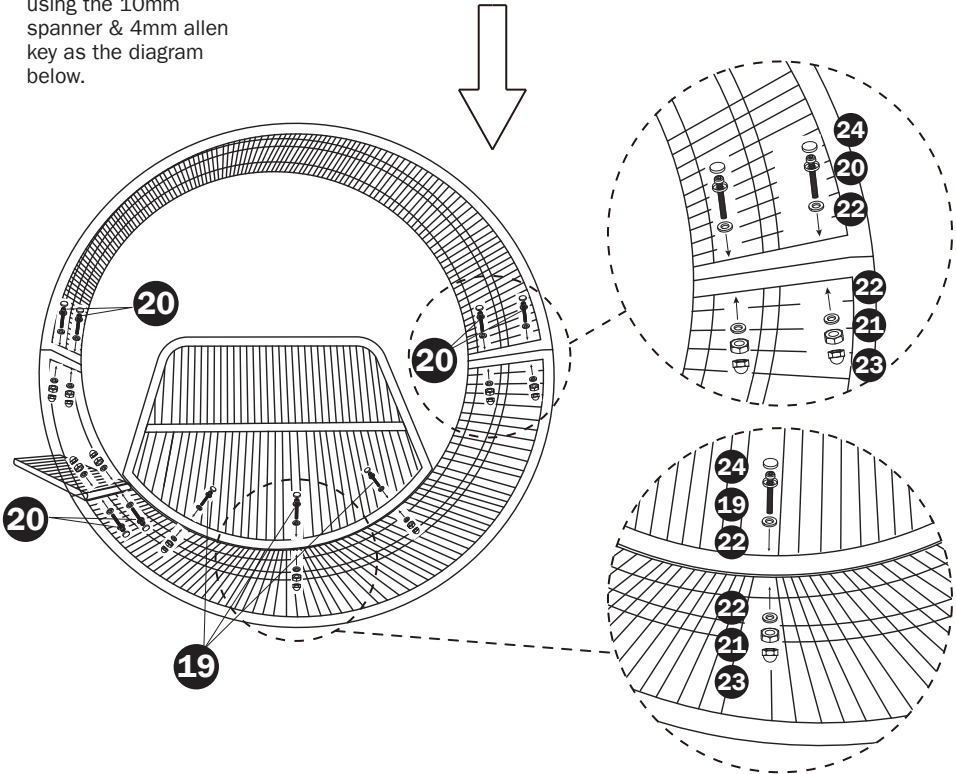

Installation - Attaching The Basket To The Frame

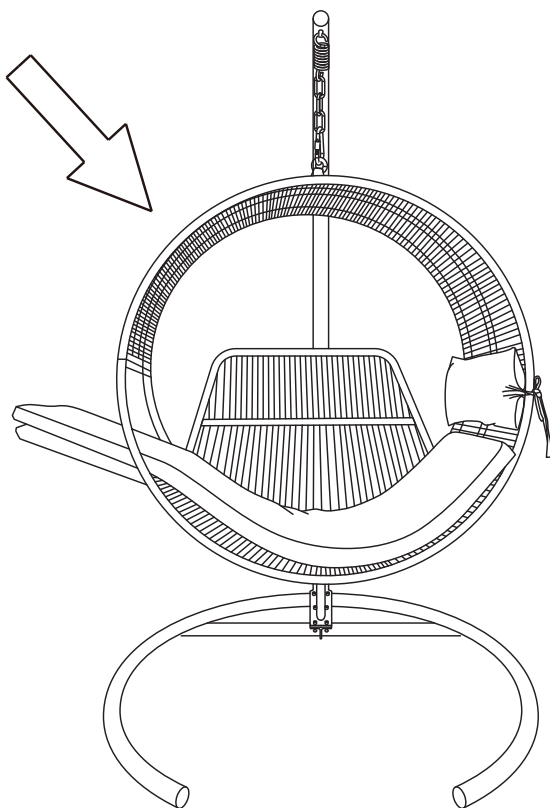
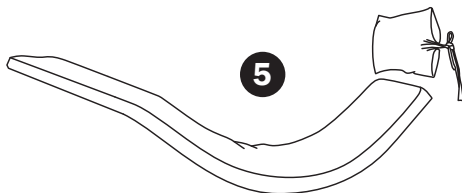
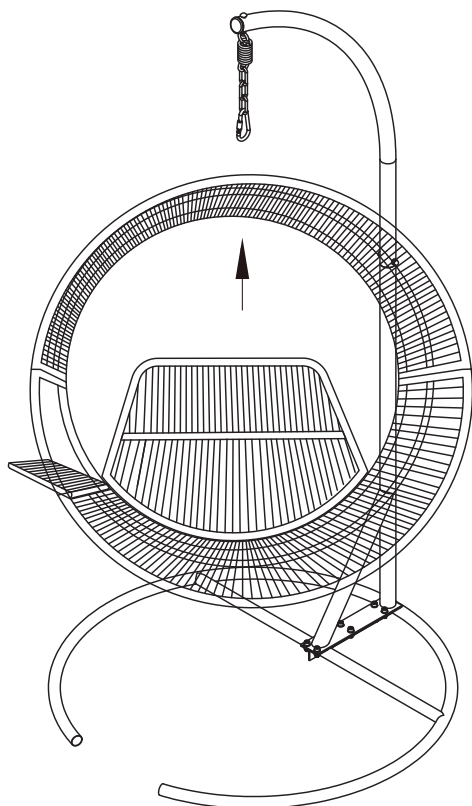

1. Place the cushion (item 5) inside the completed basket.
2. Attach the basket to the hanging frame.
3. Secure the back of the seat (item 3) to the frame using the safety strap supplied.

Care Instructions

- For best results, clean the steel frame and rattan basket with a damp cloth and then dry thoroughly.
- Avoid cleaning with abrasive materials, bleach, or solvents, as they may cause discolouration or damage to the product.
- For minor spills and stains, spot clean the cushion seat with a mild detergent and damp cloth.
- Regularly air out the cushions to prevent mildew and odours.
- Before storage, ensure the product is clean and dry. Steel rusts when exposed to air and moisture.
- Prolonged exposure to direct sunlight may fade the colour and damage the fabric. Store the chair indoors in a dry, cool place when not in use.

Technical Specifications

Product Name:	DMD Dahlia Hanging Chair with Steel Stand
Supplier Code:	DMD138
Frame:	Steel with powder coating
Basket:	PE rattan
Cushion:	Polyester fiber & polyester foam pad
Basket Dimensions:	120 x 106 x 68cm
Max Weight:	120kg

Ace Supply Co Ltd.,
Suite GA, Marsland House,
Marsland Road, Sale M33 3AQ

For Product Support:
E: support@dmdcollective.co.uk
T: +44 (0)161 543 6400

EU Regd. Address:
Ace Supply Co (Europe) Ltd.,
Dublin 2, D02 A098, ROI